



畅天(江苏)新能源工程有限公司
CHANGTIAN(JIANGSU)NEW ENERGY ENGINEERING CO.,LTD.

创绿色能源

create new energy

建美好明天

build a bright tomorrow

01 Changtian New Energy

公司简介

Company Profile

畅天(江苏)新能源工程有限公司(以下简称“畅天新能源”)主要致力于光伏多晶和单晶太阳能电池及组件的研发、生产和进出口业务。公司在昆山市设对外贸易办事处,在浙江省和江苏省拥有太阳能电池和组件的制造工厂。

畅天新能源已与很多世界著名太阳能品牌建立了长期合作关系,如晶科, 英利, 阿特斯, 中电投, 韩华, 晶澳, 天合, 尚德, REC, 昱辉等。电池效率高达17.8%以上, 组件功率从190瓦到330瓦。我们可以根据你们的需求定制。

畅天拥有30000平方的厂房, 现代化的生产设备, 最先进的电池片生产线, 确保产品的质量合格率达到99.99%。畅天新能源执行一系列的有效的质量控制, 提供12年产品质量保证和25年功率保证。

我们的贸易公司成立于2014年, 业务人员 30人以上, 其中工程师10人。我们是一个知识化、专业化、年轻化的销售团队。我们期待着与世界各地的合作。

Changtian (Jiangsu) New Energy Engineering Co.,Ltd (hereafter referred to as "Changtian New Energy) is dedicated to the research, development, manufacture and export of Poly-crystalline and mono-crystalline solar cells and solar modules, with the Foreign trading office in Jiangsu Province, and the solar factory and warehouse in Zhejiang and Jiangsu province.

Changtian New Energy also has built long-term relations of cooperation with many world famous brands such as JINKO, YINGLI, Canadian Solar, CPI, HANWHA, JA-SOLAR, Trina, SunTech, REC, RENE and so on. Our cell efficiency more than 17.8% and modules wattage from 190 w to 330 w. You can customize any kind of modules from us. Changtian factory covers an area of 30,000 square meters with modern automatic production equipment, the most advanced production line, to ensure the qualification rate of the product reached 99.99%.

Changtian New Energy executes a series of effective quality control, provide 12 years of product warranty and 25 years of power guarantee.

Our foreign trade office was founded in 2014, with sales staff more than 30 people, engineer 10 people. We are a knowledgeable, professional and young sales team. We are looking forward to cooperating with all over the world.

02 Changtian New Energy

Certificate



03 合作伙伴 Cooperative Partner



04 Changtian New Energy

Superior & Ability 优势与能力

· 供应商

多方位优质的供应商渠道有利于成本控制,提高经济效益和产品质量。

Multiple and qualified channels of suppliers are conducive to the cost control, economic improvement and product quality .

技术与设备

Technology & Equipment

现代化的自动化生产技术与设备确保产品质量合格率高达99.99%

Modern automatic production technology and equipment to ensure 99.99% qualification rate of product quality .

· 业务模式

集研发、采购、生产、销售于一体的进出口服务,为您提供低成本、高效率、高质量的解决法

Integrated the Import & Export services of research, purchase, production and sale to provide low cost, high-efficiency and quality solution .

工程项目

公司产品远销澳大利亚、巴西、菲律宾、泰国、秘鲁、印度、巴基斯坦、阿富汗、南非、智利、墨西哥、土耳其、埃及、荷兰、沙特、哥伦比亚、捷克、乌克兰、韩国、日本、美国等。

Overseas market :Australia ,Brazil , Philippines, Thailand, Peru, India, Pakistan, Afghanistan, South Africa, Chile, Mexico, Turkey, Egypt, Netherlands, Saudi Arabia, Columbia, Czech, Ukraine, Korea, Japan, The USA etc .

设计与销售团队

30名优秀销售人员和设计工程师10人。我们是一个知识化、专业化、年轻化的销售团队。

We are a young and professional team including 30 salesman and 10 engineers .

· 产业链

从电池片到光伏系统的一系列完善的产业链,为公司降低了成本,提高了企业形象。

A perfect industry chain from solar cells to PV system help us cost down and improve company image .



05 Changtian New Energy

项目展示 Project Display



06 Changtian New Energy

应用 Apply To

· 商业及公共事业屋顶 Commercial & public utilities Roof

对于商业综合体、公共事业单位如学校医院等也存在用电较高的问题，分布式光伏电站可以有效的降低能耗水平，树立绿色节能形象。



· 工业屋顶 Industrial Roof

适用于峰平时段电价较高和用电量较大的工业企业、工业园区、产业园区、物流园区等，可有效节省用电成本，实现节能减排效益。



· 大型地面电站 Power Station

将荒地、山顶、未利用地等开发利用建成大型地面电站。地面电站相对于分布式电站单项目投资大，收益高可促进当地经济发展与财政收入。大型地面电站可以有力减少碳排放，实现绿色可持续发展。



· 渔光互补

将渔业和光伏发电有效结合在一起，通过在鱼塘上加设光伏组件，水下规划鱼虾养殖，大大提高了单亩土地的利用效率，实现了立体经济农业。光伏卖电产生的收益为传统渔业养殖带来了新的经济增长点。



太阳能路灯 Solar street lamp

用于代替传统公用电力照明的路灯。无需铺设线缆、无需交流供电、不产生电费；采用直流供电、控制；具有稳定性好、寿命长、发光效率高，安装维护简便、安全性能高、节能环保、经济实用等优点。可广泛应用于城市主、次干道、小区、工厂、旅游景点、停车场等场所。

07 Changtian New Energy

Why Select Solar Energy

为何选择太阳能

太阳能是地球上最丰富的可用能源

Solar energy is the most abundant available resource on the earth.

太阳能在地球上每照射 15 分钟所产生的能量，就可以满足全球全年的能源需求。事实证明，太阳能光伏是一种可靠的发电方式，目前世界各国和各地区均有很大一部分能源来自太阳能。

太阳能是更加安全的清洁能源

Solar energy is more secure and clean energy
实现可观的碳减排，减少争端，促进人类发展

太阳能电力是一种灵活的能源

Solar energy is a kind of flexible energy.
只要有阳光，就可以利用太阳能发电。您既可以将太阳能电池组件安装在屋顶也可以放在一片空地。太阳能电池组件所产生的电力便可以为一个家庭或整个城市供电。太阳能电力还可以解决全球15亿无电人口的用电难题。

太阳能电力还是一项可靠的投资

Solar energy is a reliable investment.
项目开发商，土地所有者和业主可以将太阳能电力出售给电力公司，在太阳能系统使用的整个生命周期内获得稳定的收入。无论您的太阳能电力是自用还是出售，都可以在不久的将来获得可观的回报。我们太阳能产品的可靠性能助您在未来的数十年内持续获利。

太阳能电力能够满足人类持续增长的需求

The solar energy can meet the needs of the human being.
根据国际能源署报告显示，2002年至2030年，全球电力需求预计将从16.1 万亿度增至31.7 万亿度。IEA 指出全球超过 66% 的电力由煤、天然气和石油等化石燃料产生，在化石燃料储量持续下降和电力消耗不断上升的推动下，全球电价将不断攀升，消费者的电费也会持续上涨。人们迫切需要开发可持续的替代能源。



畅天(江苏)新能源工程有限公司

CHANGTIAN(JIANGSU)NEW ENERGY ENGINEERING CO.,LTD.

Add/ 地址：昆山市北门路都市汇1幢701室

Tel / 电话：0512-57756820

Fax / 传真：0512-57756820

Web/ 网站：www.chinactosolar.com

www.ctsolar.en.alibaba.com



畅天(江苏)新能源工程有限公司
CHANGTIAN(JIANGSU)NEW ENERGY ENGINEERING CO.,LTD.

CT-HS195-72M CT-HS200-72M
CT-HS205-72M CT-HS210-72M
CT-HS215-72M



High Efficiency:
High module conversion efficiency, through innovative manufacturing technology.



PID Free:
Limited power degradation of module caused by PID effect is guaranteed under 60 °C/85% RH condition for mass production.



Low-light Performance:
Advanced glass and surface texturing allow for excellent performance in low-light environments.



Severe Weather Resilience:
Certified to withstand: wind load (2400 Pascal) and snow load (5400 Pascal).



Durability against extreme environmental conditions:
High salt mist and ammonia resistance certified by TÜV NORD.



Temperature Coefficient:
Improved temperature coefficient decreases power loss during high temperatures.

Reliable Quality

- Fully automatic welding and automatic production line
- EL test to avoid defective panels .

72 cells 195-215W
Mono Output Power

16.2% 0~+5W
Efficiency Tolerance

Quality CT solar panels provide more benefit guarantee to customers. CT solar is famous for its high power output , easy installation and durable .

畅天(江苏)新能源工程有限公司



畅天(江苏)新能源工程有限公司
CHANGTIAN(JIANGSU)NEW ENERGY ENGINEERING CO.,LTD.

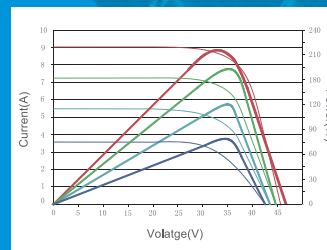
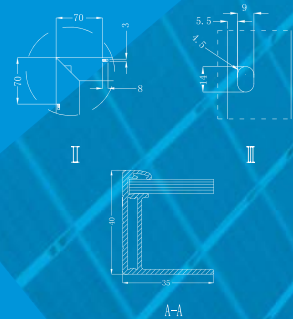
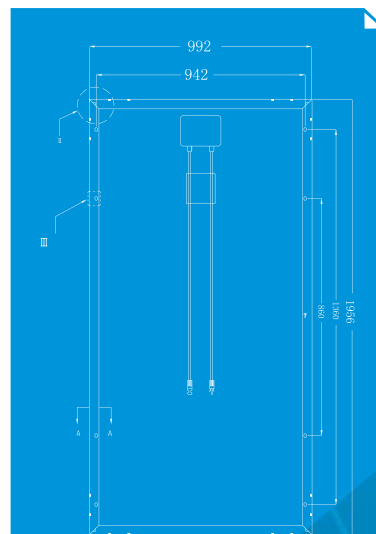

STC	CT-HS195-72M	CT-HS200-72M	CT-HS205-72M	CT-HS210-72M	CT-HS215-72M
最大额定功率(Pm)	195	200	205	210	215
最大工作电压(Vm)	37.1	37.5	37.9	38.3	38.7
最大工作电流(Im)	5.26	5.34	5.41	5.49	5.56
开路电压(Voc)	44.6	44.6	44.7	44.8	44.9
短路电流(Isc)	5.69	5.80	5.91	6.02	6.14
组件转换效率(%)	15.3	15.7	16.1	16.4	16.8
组件工作温度(°C)	-40~+85°C				
最大系统电压(V)	1000V				
最大熔断电流(A)	15A				
功率公差(W)	0~+5W				

STC: 辐照度1000W/M2, 组件温度25°C, AM=1.5

NOCT	CT-HS195-72M	CT-HS200-72M	CT-HS205-72M	CT-HS210-72M	CT-HS215-72M
最大额定功率(Pm)	144	147	151	155	158
最大工作电压(Vm)	33.8	34.1	34.5	34.9	35.2
最大工作电流(Im)	4.27	4.31	4.38	4.45	4.49
开路电压(Voc)	40.8	41.0	41.1	41.2	41.3
短路电流(Isc)	4.61	4.70	4.79	4.88	4.97

NOCT: 辐照度800W/M2, 环境温度20°C, AM=1.5, 风速1m/s

温度系数 (Temperature Coefficient)

标称电池工作温度 (NOCT)	45 ± 2°C
温度系数 (Pmax)	-0.43%/°C
温度系数 (Voc)	-0.31%/°C
温度系数 (Isc)	0.046%/°C

机械系数 (Mechanical coefficient)

电池类型 (Cells Type)	Monocrystalline Silicon
电池尺寸 (Cells Size)	156X156mm
电池数量 (Cells Number)	72 (6X12)
组件尺寸 (Module Size)	1956X992X40mm
重量 (Weight)	15.5kg
电缆线 (Cable)	4mm², 900mm
连接器 (Connector)	MC4 or MC Compatible
边框 (Frame)	Anodized Aluminum
接线盒 (Junction Box)	IP67 Rated

10 Year Product Warranty • 25 Year Linear Power Warranty

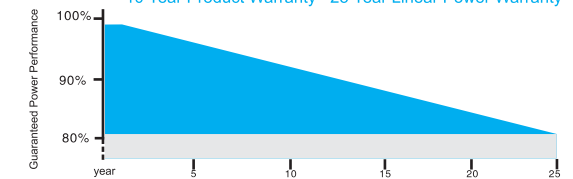



AD255-60S-5 AD260-60S-5
AD265-60S-5 AD270-60S-5
AD275-60S-5

5BB Mono Solar Panels

5BB

5 busbar solar cell adopts new technology to improve the efficiency of modules, offers a better aesthetic appearance, making it perfect for rooftop installation.

285W
Maximum output power

Max power have 285w because of low resistance and higher FF.

Low
MICROCRACK

Anti microcrack enhanced and power degradation less than 3BB by over 60% if microcrack occurred.

PID Free
Strengthen

Limited power degradation of module caused by PID effect is guaranteed under 60°C/85% RH condition for mass production.

IP67
Better protection

Severe Weather Resilience:
Certified to withstand: wind load (2400 Pascal) and snow load (5400 Pascal).

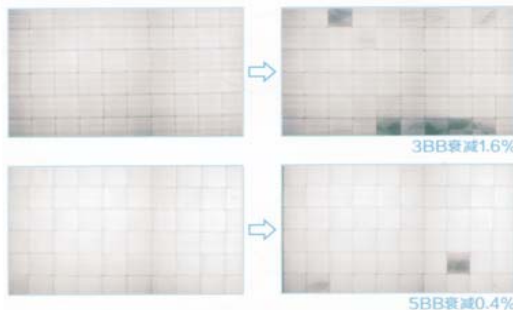

畅天(江苏)新能源工程有限公司

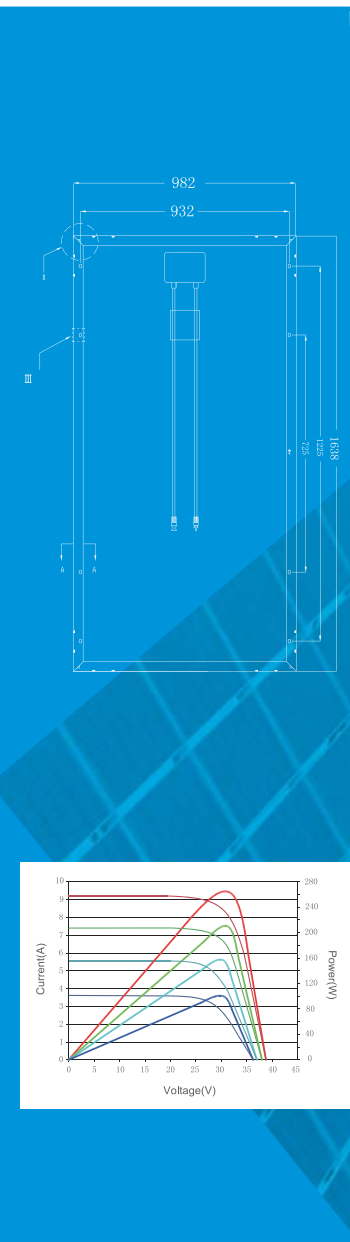

STC	CT-HS265-60S-5	CT-HS270-60S-5	CT-HS275-60S-5	CT-HS280-60S-5	CT-HS285-60S-5
最大额定功率(Pm)	265	270	275	280	285
最大工作电压(Vm)	30.4	50.0	50.3	50.6	50.9
最大工作电流(Im)	8.72	5.40	5.47	5.54	5.60
开路电压(Voc)	38.4	60.2	60.3	60.4	60.5
短路电流(Isc)	9.32	5.76	5.82	5.58	5.94
最大系统电压(V)			1000V		
最大熔断电流(A)			15A		
功率公差(W)			0~+5W		

STC: 辐照度1000W/M2, 组件温度25°C, AM=1.5

NOCT	CT-HS265-60S-5	CT-HS270-60S-5	CT-HS275-60S-5	CT-HS280-60S-5	CT-HS285-60S-5
最大额定功率(Pm)	193	197	200	204	208
最大工作电压(Vm)	27.7	27.8	28.1	28.4	28.8
最大工作电流(Im)	6.98	7.06	7.65	7.69	7.72
开路电压(Voc)	35.3	35.5	35.7	35.9	36.1
短路电流(Isc)	7.55	7.61	7.65	7.69	7.72

NOCT: 辐照度800W/M2, 环境温度20°C, AM=1.5, 风速1m/s

温度系数

标称电池工作温度 (NOCT)	45 ± 2°C
温度系数 (Pmax)	-0.42%/°C
温度系数 (Voc)	-0.31%/°C
温度系数 (Isc)	0.039%/°C

机械系数

电池类型 (Cells Type)	Monocrystalline Silicon(5BB)
电池尺寸 (Cells Size)	156X156mm
电池数量 (Cells Number)	60 (6X10)
组件尺寸 (Module Size)	1638X982X40mm
重量 (Weight)	20kg
电缆线 (Cable)	4mm ² ,900mm
连接器 (Connector)	M4C or MC Compatible
边框 (Frame)	Anodized Aluminum
接线盒 (Junction Box)	IP67 Rated

10 Year Product Warranty • 25 Year Linear Power Warranty

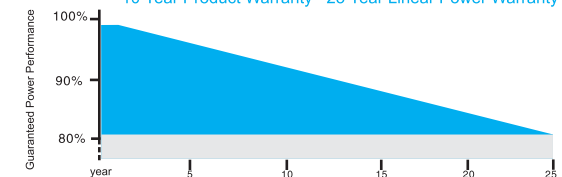



AD255-60P-5 AD260-60P-5
AD265-60P-5 AD270-60P-5
AD275-60P-5

5BB Poly Solar Panels

5BB

5 busbar solar cell adopts new technology to improve the efficiency of modules, offers a better aesthetic appearance, making it perfect for rooftop installation.

275W

Maximum output power

Max power have 275w because of low resistance and higher FF.

Low

MICROCRACK

Anti microcrack enhanced and power degradation less than 3BB by over 60% if microcrack occurred.

PID Free

Strengthen

Limited power degradation of module caused by PID effect is guaranteed under 60°C/85% RH condition for mass production.

IP67

Better protection

Severe Weather Resilience: Certified to withstand: wind load (2400 Pascal) and snow load (5400 Pascal).

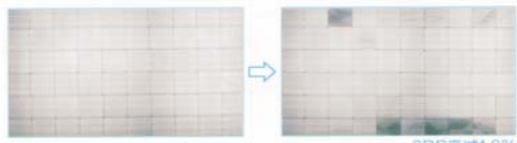

3BB衰减1.6%



5BB衰减0.4%

畅天(江苏)新能源工程有限公司

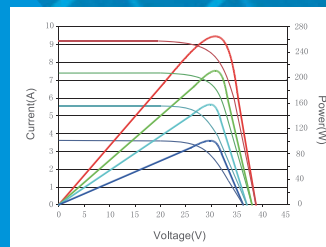
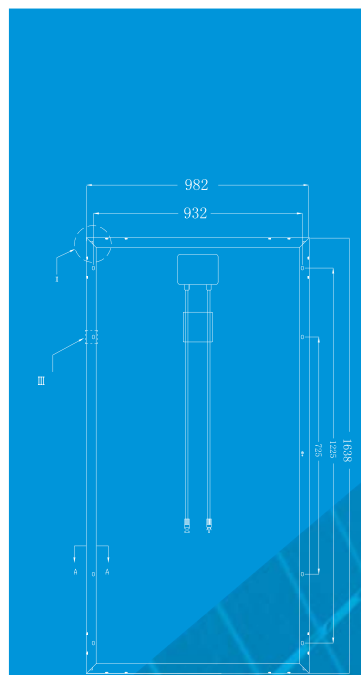

STC	CT-HS255-60P-5	CT-HS260-60P-5	CT-HS265-60P-5	CT-HS270-60P-5	CT-HS275-60P-5
最大额定功率(Pm)	255	260	265	270	275
最大工作电压(Vm)	30.1	30.4	30.8	31.1	31.4
最大工作电流(Im)	8.47	8.54	8.61	8.68	8.76
开路电压(Voc)	37.6	37.8	38.0	38.1	38.3
短路电流(Isc)	9.02	9.08	9.14	9.20	9.26
最大系统电压(V)			1000V		
最大熔断电流(A)			15A		
功率公差(W)			0~+5W		

STC: 辐照度1000W/M2, 组件温度25°C, AM=1.5

NOCT	CT-HS255-60P-5	CT-HS260-60P-5	CT-HS265-60P-5	CT-HS270-60P-5	CT-HS275-60P-5
最大额定功率(Pm)	185	189	193	196	200
最大工作电压(Vm)	27.4	27.8	28.0	28.1	28.3
最大工作电流(Im)	6.76	6.81	6.90	6.99	7.08
开路电压(Voc)	34.6	34.7	34.9	35.0	35.2
短路电流(Isc)	7.31	7.28	7.31	7.34	7.37

NOCT: 辐照度800W/M2, 环境温度20°C, AM=1.5, 风速1m/s

温度系数

标称电池工作温度 (NOCT)	45 ± 2°C
温度系数 (Pmax)	-0.42%/°C
温度系数 (Voc)	-0.31%/°C
温度系数 (Isc)	0.046%/°C

机械系数

电池类型 (Cells Type)	Polycrystalline Silicon(5BB)
电池尺寸 (Cells Size)	156X156mm
电池数量 (Cells Number)	60 (6X10)
组件尺寸 (Module Size)	1638X982X40mm
重量 (Weight)	20kg
电缆线 (Cable)	4mm ² ,900mm
连接器 (Connector)	M4C or MC Compatible
边框 (Frame)	Anodized Aluminum
接线盒 (Junction Box)	IP67 Rated

10 Year Product Warranty • 25 Year Linear Power Warranty

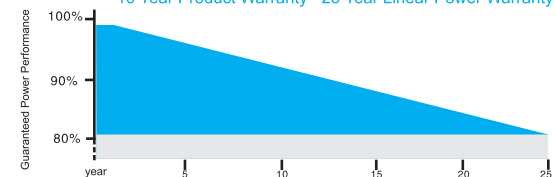



Poly Solar Cells (4BB)

Dimensions	156mm × 156mm ± 0.5mm
Thickness	200um ± 20um
Front	Silicon Nitride antireflection coating
Back	Back surface field (aluminium)

TKVoltage	-0.32 %/ °C
TKCurrent	+0.02 %/ °C
TKPower	-0.45 %/ °C

Electric Feature

Efficiency	Pmpp	Imp	Voc	Isc
18.40%	4.48W	8.28A	0.638V	8.77A
18.20%	4.45W	8.22A	0.638V	8.71A
17.00%	4.40W	8.18A	0.635V	8.67A
17.80%	4.36W	8.14A	0.631V	8.64A
17.60%	4.31W	8.10A	0.628V	8.60A
17.40%	4.27W	8.05A	0.626V	8.55A

Testing conditions : 1000W/m2 , AM 1.5 , 25 °C , Tolerance : Efficiency ± 0.2% abs.,Pmpp± 1.5%rel.

Printing Outline

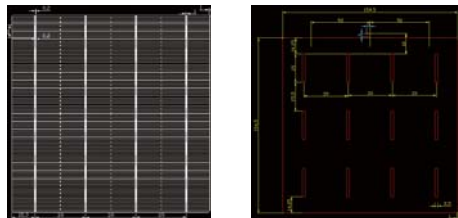

www.chinactsolar.com 0512-57756820

Poly Solar Cells (3BB)

Dimensions	156mm × 156mm ± 0.5mm
Thickness	200um ± 20um
Front	Silicon Nitride antireflection coating
Back	Back surface field (aluminium)

TKVoltage	-0.32 %/ °C
TKCurrent	+0.02 %/ °C
TKPower	-0.45 %/ °C

Electric Feature

Efficiency	Pmpp	Imp	Voc	Isc
18.20%	4.43W	8.30A	0.633V	8.85A
18.00%	4.38W	8.24A	0.632V	8.80A
17.80%	4.33W	8.18A	0.630V	8.75A
17.60%	4.28W	8.12A	0.629V	8.70A
17.40%	4.23W	8.07A	0.628V	8.65A
17.20%	4.19W	8.01A	0.627V	8.60A

Testing conditions : 1000W/m2 , AM 1.5 , 25 °C , Tolerance : Efficiency ± 0.2% abs.,Pmpp± 1.5%rel.

Printing Outline

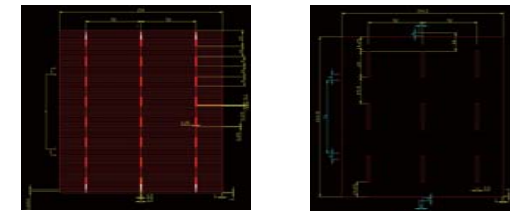

www.chinactsolar.com 0512-57756820



畅天(江苏)新能源工程有限公司
CHANGTIAN(JIANGSU)NEW ENERGY ENGINEERING CO.,LTD.

CT-HS300-72S CT-HS305-72S
CT-HS310-72S CT-HS315-72S
CT-HS320-72S



High Efficiency:
High module conversion efficiency, through innovative manufacturing technology.



PID Free:
Limited power degradation of module caused by PID effect is guaranteed under 60 °C/85% RH condition for mass production.



Low-light Performance:
Advanced glass and surface texturing allow for excellent performance in low-light environments.



Severe Weather Resilience:
Certified to withstand: wind load (2400 Pascal) and snow load (5400 Pascal).



Durability against extreme environmental conditions:
High salt mist and ammonia resistance certified by TUV NORD.



Temperature Coefficient:
Improved temperature coefficient decreases power loss during high temperatures.

Reliable Quality

- Fully automatic welding and automatic production line
- EL test to avoid defective panels .

www.chinactsolar.com 0512-57756820



畅天(江苏)新能源工程有限公司
CHANGTIAN(JIANGSU)NEW ENERGY ENGINEERING CO.,LTD.

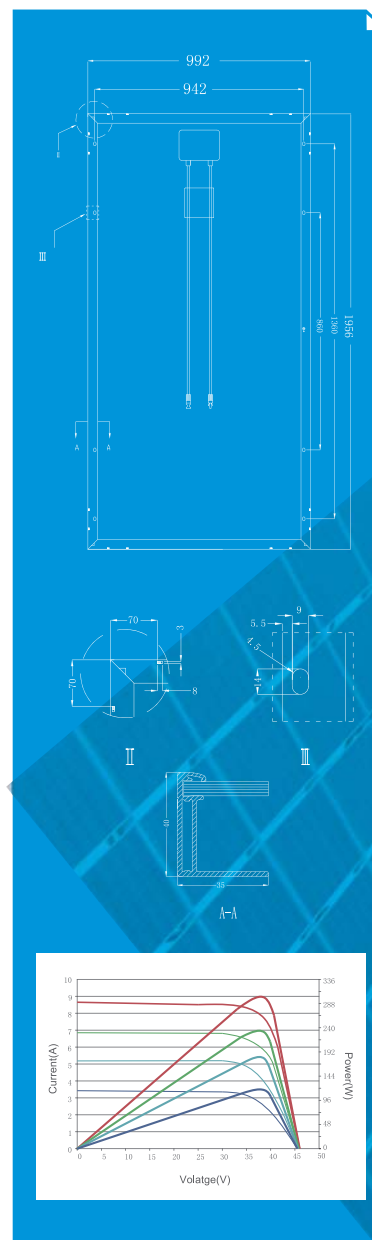

STC	CT-HS300-72S	CT-HS305-72S	CT-HS310-72S	CT-HS315-72S	CT-HS320-72S
最大额定功率(Pm)	300	305	310	315	320
最大工作电压(Vm)	36.5	36.6	36.7	36.8	36.9
最大工作电流(Im)	8.22	8.34	8.45	8.56	8.68
开路电压(Voc)	44.9	44.9	45.0	45.1	45.2
短路电流(Isc)	8.72	8.83	8.95	9.06	9.18
组件转换效率(%)	15.6	15.9	16.2	16.4	16.7
组件工作温度(°C)	-40~+85°C				
最大系统电压(V)	1000V				
最大熔断电流(A)	15A				
功率公差(W)	0~+5W				

STC: 辐照度1000W/M2, 组件温度25°C, AM=1.5

NOCT	CT-HS300-72S	CT-HS305-72S	CT-HS310-72S	CT-HS315-72S	CT-HS320-72S
最大额定功率(Pm)	211	224	228	232	236
最大工作电压(Vm)	33.2	33.3	33.4	33.5	33.6
最大工作电流(Im)	6.65	6.73	6.84	6.93	7.03
开路电压(Voc)	41.3	41.3	41.4	41.5	41.6
短路电流(Isc)	7.06	7.15	7.25	7.34	7.44

NOCT: 辐照度800W/M2, 环境温度20°C, AM=1.5, 风速1m/s

温度系数	
标称电池工作温度 (NOCT)	45 ± 2°C
温度系数 (Pmax)	-0.43%/°C
温度系数 (Voc)	-0.31%/°C
温度系数 (Isc)	0.046%/°C

机械系数	
电池类型 (Cells Type)	Monocrystalline Silicon
电池尺寸 (Cells Size)	125X125mm
电池数量 (Cells Number)	72 (6X12)
组件尺寸 (Module Size)	1956X992X40mm
重量 (Weight)	28kg
电缆线 (Cable)	4mm², 900mm
连接器 (Connector)	MC4 or MC Compatible
边框 (Frame)	Anodized Aluminum
接线盒 (Junction Box)	IP67 Rated

10 Year Product Warranty • 25 Year Linear Power Warranty

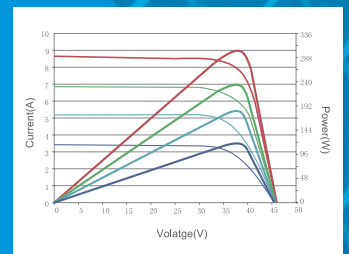
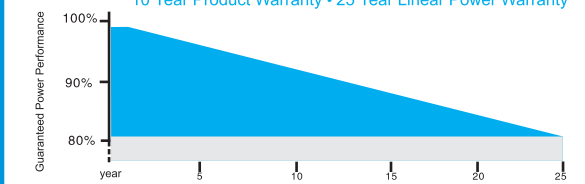

72 cells 300-320W
Mono Output Power

16.7% 0~+5W
Efficiency Tolerance

Quality CT solar panels provide more benefit guarantee to customers. CT solar is famous for its high power output , easy installation and durable .

畅天(江苏)新能源工程有限公司

www.chinactsolar.com 0512-57756820



畅天(江苏)新能源工程有限公司
CHANGTIAN(JIANGSU)NEW ENERGY ENGINEERING CO.,LTD.

CT-HS290-72P CT-HS295-72P
CT-HS300-72P CT-HS305-72P
CT-HS310-72P



High Efficiency:
High module conversion efficiency, through innovative manufacturing technology.



PID Free:
Limited power degradation of module caused by PID effect is guaranteed under 60 °C/85% RH condition for mass production.



Low-light Performance:
Advanced glass and surface texturing allow for excellent performance in low-light environments.



Severe Weather Resilience:
Certified to withstand: wind load (2400 Pascal) and snow load (5400 Pascal).



Durability against extreme environmental conditions:
High salt mist and ammonia resistance certified by TUV NORD.



Temperature Coefficient:
Improved temperature coefficient decreases power loss during high temperatures.

Reliable Quality

- Fully automatic welding and automatic production line
- EL test to avoid defective panels .



畅天(江苏)新能源工程有限公司
CHANGTIAN(JIANGSU)NEW ENERGY ENGINEERING CO.,LTD.

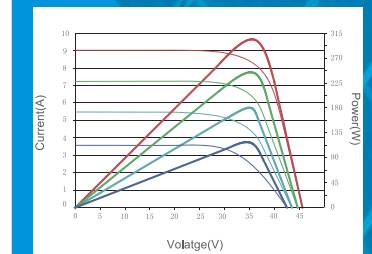
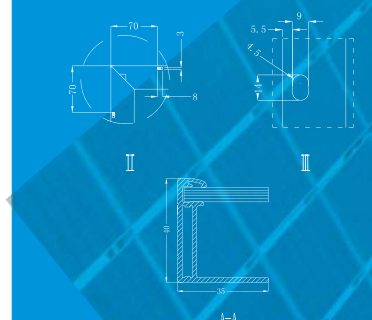
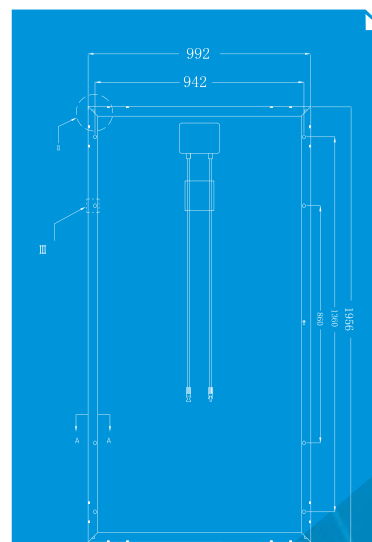

STC	CT-HS290-72P	CT-HS295-72P	CT-HS300-72P	CT-HS305-72P	CT-HS310-72P
最大额定功率(Pm)	290	295	300	305	310
最大工作电压(Vm)	35.9	36.0	36.1	36.2	36.3
最大工作电流(Im)	8.08	8.20	8.31	8.43	8.54
开路电压(Voc)	44.5	44.6	44.7	44.8	44.9
短路电流(Isc)	8.62	8.74	8.85	8.96	9.08
组件转换效率(%)	15.1	15.4	15.6	15.9	16.2
组件工作温度(°C)	-40~+85°C				
最大系统电压(V)	1000V				
最大熔断电流(A)	15A				
功率公差(W)	0~+5W				

STC: 辐照度1000W/M2, 组件温度25°C, AM=1.5

NOCT	CT-HS290-72P	CT-HS295-72P	CT-HS300-72P	CT-HS305-72P	CT-HS310-72P
最大额定功率(Pm)	211	215	219	222	226
最大工作电压(Vm)	32.7	32.8	32.9	32.9	33.0
最大工作电流(Im)	6.46	6.56	6.66	6.74	6.83
开路电压(Voc)	40.9	41.0	41.1	41.2	41.3
短路电流(Isc)	6.98	7.08	7.17	7.26	7.35

NOCT: 辐照度800W/M2, 环境温度20°C, AM=1.5, 风速1m/s

温度系数	
标称电池工作温度 (NOCT)	45 ± 2°C
温度系数 (Pmax)	-0.43%/°C
温度系数 (Voc)	-0.31%/°C
温度系数 (Isc)	0.046%/°C

机械系数	
电池类型 (Cells Type)	Polycrystalline Silicon
电池尺寸 (Cells Size)	156X156mm
电池数量 (Cells Number)	72 (6X12)
组件尺寸 (Module Size)	1956X992X40mm
重量 (Weight)	20kg
电缆线 (Cable)	4mm²,900mm
连接器 (Connector)	MC4 or MC Compatible
边框 (Frame)	Anodized Aluminum
接线盒 (Junction Box)	IP67 Rated

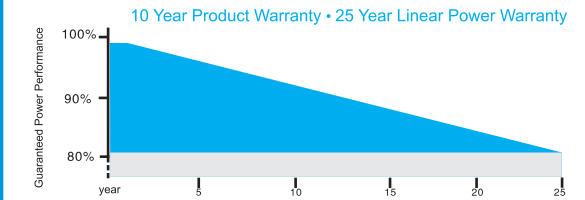

72 cells 295-310W
Poly Output Power

16.2% 0~+5W
Efficiency Tolerance

Quality CT solar panels provide more benefit guarantee to customers. CT solar is famous for its high power output , easy installation and durable .

畅天(江苏)新能源工程有限公司

CT-HS265-96M CT-HS270-96M
CT-HS275-96M CT-HS280-96M
CT-HS285-96M



High Efficiency:
High module conversion efficiency, through innovative manufacturing technology.



PID Free:
Limited power degradation of module caused by PID effect is guaranteed under 60 °C/85% RH condition for mass production.



Low-light Performance:
Advanced glass and surface texturing allow for excellent performance in low-light environments.



Severe Weather Resilience:
Certified to withstand: wind load (2400 Pascal) and snow load (5400 Pascal).



Durability against extreme environmental conditions:
High salt mist and ammonia resistance certified by TÜV NORD.



Temperature Coefficient:
Improved temperature coefficient decreases power loss during high temperatures.

Reliable Quality

- Fully automatic welding and automatic production line
- EL test to avoid defective panels .

96 cells 265-285W
Mono Output Power

16.9% 0~+5W
Efficiency Tolerance

Quality CT solar panels provide more benefit guarantee to customers. CT solar is famous for its high power output , easy installation and durable .

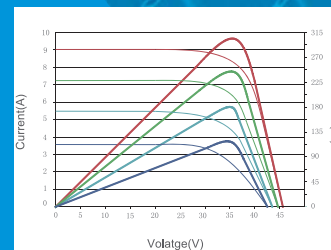
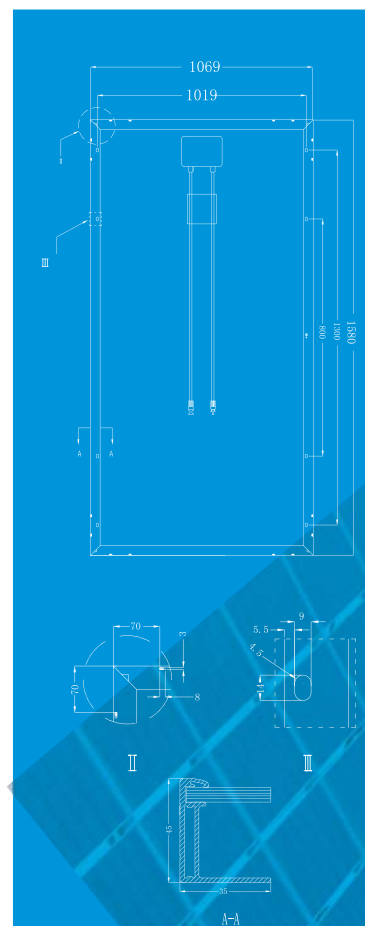

STC	CT-HS265-96M	CT-HS270-96M	CT-HS275-96M	CT-HS280-96M	CT-HS285-96M
最大额定功率(Pm)	265	270	275	280	285
最大工作电压(Vm)	49.7	50.0	50.3	50.6	50.9
最大工作电流(Im)	5.34	5.40	5.47	5.54	5.60
开路电压(Voc)	60.1	60.2	60.3	60.4	60.5
短路电流(Isc)	5.70	5.76	5.82	5.58	5.94
组件转换效率(%)	15.7	16.0	16.3	16.6	16.9
组件工作温度(°C)	-40~+85°C				
最大系统电压(V)	1000V				
最大熔断电流(A)	15A				
功率公差(W)	0~+5W				

STC: 辐照度1000W/M2, 组件温度25°C, AM=1.5

NOCT	CT-HS265-96M	CT-HS270-96M	CT-HS275-96M	CT-HS280-96M	CT-HS285-96M
最大额定功率(Pm)	195	199	202	206	210
最大工作电压(Vm)	45.2	45.5	45.8	46.0	46.3
最大工作电流(Im)	4.31	4.38	4.42	4.48	4.54
开路电压(Voc)	55.3	55.4	55.5	55.6	55.7
短路电流(Isc)	4.62	4.67	4.71	4.76	4.81

NOCT: 辐照度800W/M2, 环境温度20°C, AM=1.5, 风速1m/s

温度系数	
标称电池工作温度 (NOCT)	45 ± 2°C
温度系数 (Pmax)	-0.43%/°C
温度系数 (Voc)	-0.31%/°C
温度系数 (Isc)	0.046%/°C

机械系数	
电池类型 (Cells Type)	Monocrystalline Silicon
电池尺寸 (Cells Size)	125X125mm
电池数量 (Cells Number)	96 (8X12)
组件尺寸 (Module Size)	1580X1069X45mm
重量 (Weight)	21kg
电缆线 (Cable)	4mm ² ,900mm
连接器 (Connector)	M4C or MC Compatible
边框 (Frame)	Anodized Aluminum
接线盒 (Junction Box)	IP67 Rated

10 Year Product Warranty • 25 Year Linear Power Warranty

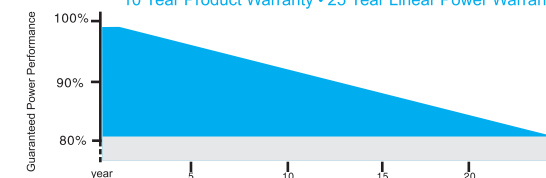



畅天(江苏)新能源工程有限公司
CHANGTIAN(JIANGSU)NEW ENERGY ENGINEERING CO.,LTD.



60 cells **245-265W**
Poly **Output Power**

16.5% **0~+5W**
Efficiency **Tolerance**

Quality CT solar panels provide more benefit guarantee to customers. CT solar is famous for its high power output, easy installation and durable.

畅天(江苏)新能源工程有限公司

CT-HS245-60P CT-HS250-60P
CT-HS255-60P CT-HS260-60P
CT-HS265-60P



High Efficiency:
High module conversion efficiency, through innovative manufacturing technology.



PID Free:
Limited power degradation of module caused by PID effect is guaranteed under 60 C/85% RH condition for mass production.



Low-light Performance:
Advanced glass and surface texturing allow for excellent performance in low-light environments.



Severe Weather Resilience:
Certified to withstand: wind load (2400 Pascal) and snow load (5400 Pascal).



Durability against extreme environmental conditions:
High salt mist and ammonia resistance certified by TUV NORD.



Temperature Coefficient:
Improved temperature coefficient decreases power loss during high temperatures.

Reliable Quality

- Fully automatic welding and automatic production line
- EL test to avoid defective panels.

www.chinactsolar.com 0512-57756820



畅天(江苏)新能源工程有限公司
CHANGTIAN(JIANGSU)NEW ENERGY ENGINEERING CO.,LTD.

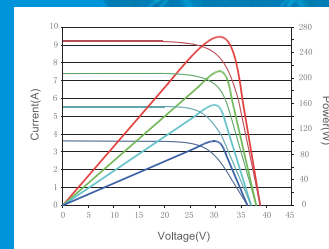
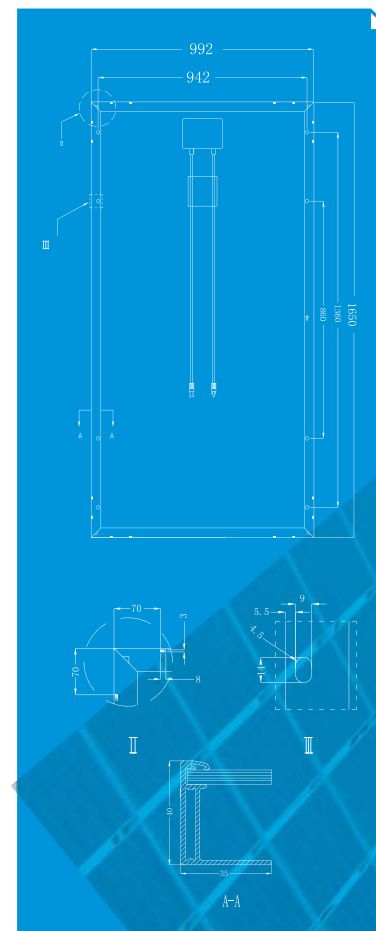

STC	CT-HS245-60P	CT-HS250-60P	CT-HS255-60P	CT-HS260-60P	CT-HS265-60P
最大额定功率(Pm)	245	250	255	260	265
最大工作电压(Vm)	30.2	30.4	30.6	30.8	38.3
最大工作电流(Im)	8.12	8.23	8.34	8.45	8.56
开路电压(Voc)	36.8	36.9	36.9	37.0	37.0
短路电流(Isc)	8.74	8.88	9.02	9.16	9.31
组件转换效率(%)	15.2	15.5	15.9	16.2	16.5
组件工作温度(C)	-40~+85°C				
最大系统电压(V)	1000V				
最大熔断电流(A)	15A				
功率公差(W)	0~+5W				

STC: 辐照度1000W/M2, 组件温度25°C, AM=1.5

NOCT	CT-HS255-60P	CT-HS260-60P	CT-HS265-60P	CT-HS270-60P	CT-HS275-60P
最大额定功率(Pm)	179	182	186	189	193
最大工作电压(Vm)	27.5	27.5	27.8	28.0	28.2
最大工作电流(Im)	6.50	6.58	6.67	6.76	6.85
开路电压(Voc)	33.9	33.9	34.0	34.0	34.1
短路电流(Isc)	7.08	7.19	7.31	7.42	7.54

NOCT: 辐照度800W/M2, 环境温度20°C, AM=1.5, 风速1m/s

温度系数

标称电池工作温度 (NOCT)	45 ± 2°C
温度系数 (Pmax)	-0.43%/°C
温度系数 (Voc)	-0.31%/°C
温度系数 (Isc)	+0.046%/°C

机械系数

电池类型 (Cells Type)	Polycrystalline Silicon
电池尺寸 (Cells Size)	156X156mm
电池数量 (Cells Number)	60 (6X10)
组件尺寸 (Module Size)	1650X992X40mm
重量 (Weight)	20kg
电缆线 (Cable)	4mm ² ,900mm
连接器 (Connector)	MC4 or MC Compatible
边框 (Frame)	Anodized Aluminum
接线盒 (Junction Box)	IP67 Rated

10 Year Product Warranty • 25 Year Linear Power Warranty

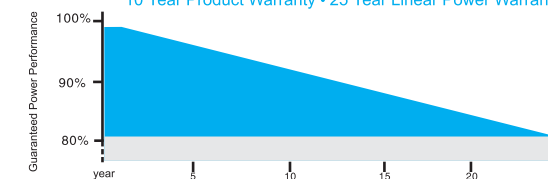

www.chinactsolar.com 0512-57756820



CT-HS245-60S CT-HS250-60S
CT-HS255-60S CT-HS260-60S
CT-HS265-60S



High Efficiency:
High module conversion efficiency, through innovative manufacturing technology.



PID Free:
Limited power degradation of module caused by PID effect is guaranteed under 60 °C/85% RH condition for mass production.



Low-light Performance:
Advanced glass and surface texturing allow for excellent performance in low-light environments.



Severe Weather Resilience:
Certified to withstand: wind load (2400 Pascal) and snow load (5400 Pascal).



Durability against extreme environmental conditions:
High salt mist and ammonia resistance certified by TUV NORD.



Temperature Coefficient:
Improved temperature coefficient decreases power loss during high temperatures.

Reliable Quality

- Fully automatic welding and automatic production line
- EL test to avoid defective panels .

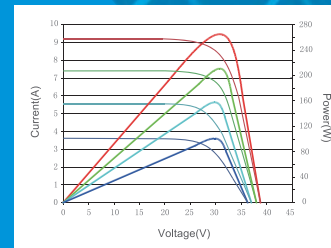
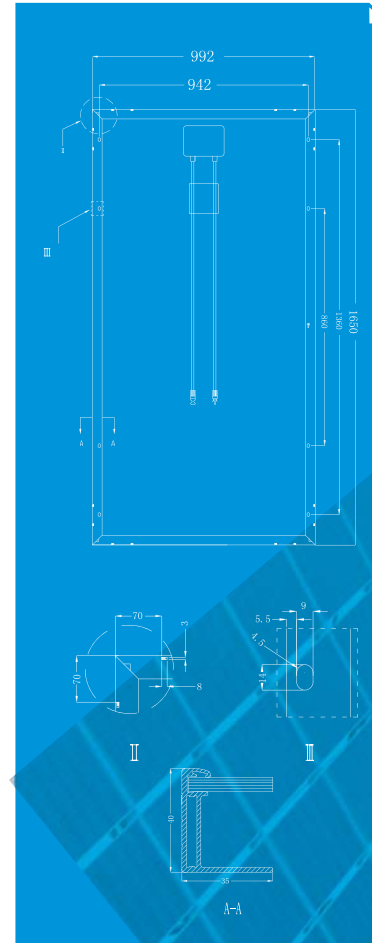

STC	CT-HS245-60S	CT-HS250-60S	CT-HS255-60S	CT-HS260-60S	CT-HS265-60S
最大额定功率(Pm)	245	250	255	260	265
最大工作电压(Vm)	30.3	30.4	30.5	30.6	30.7
最大工作电流(Im)	8.09	8.23	8.37	8.50	8.63
开路电压(Voc)	37.4	37.5	37.6	37.6	37.7
短路电流(Isc)	8.55	8.68	8.81	8.94	9.08
组件转换效率(%)	15.2	15.5	15.9	16.2	16.5
组件工作温度(°C)	-40~+85°C				
最大系统电压(V)	1000V				
最大熔断电流(A)	15A				
功率公差(W)	0~+5W				

STC: 辐照度1000W/M2, 组件温度25°C, AM=1.5

NOCT	CT-HS245-60S	CT-HS250-60S	CT-HS255-60S	CT-HS260-60S	CT-HS265-60S
最大额定功率(Pm)	180	184	188	191	195
最大工作电压(Vm)	27.6	27.7	27.8	27.8	27.9
最大工作电流(Im)	6.52	6.66	6.78	6.86	6.98
开路电压(Voc)	34.4	34.5	34.6	34.6	34.7
短路电流(Isc)	6.93	7.03	7.14	7.24	7.35

NOCT: 辐照度800W/M2, 环境温度20°C, AM=1.5, 风速1m/s

温度系数

标称电池工作温度 (NOCT)	45 ± 2°C
温度系数 (Pmax)	-0.43%/°C
温度系数 (Voc)	-0.31%/°C
温度系数 (Isc)	0.046%/°C

机械系数

电池类型 (Cells Type)	Monocrystalline Silicon
电池尺寸 (Cells Size)	156X156mm
电池数量 (Cells Number)	60 (6X10)
组件尺寸 (Module Size)	1650X992X40mm
重量 (Weight)	20kg
电缆线 (Cable)	4mm²,900mm
连接器 (Connector)	MC4 or MC Compatible
边框 (Frame)	Anodized Aluminum
接线盒 (Junction Box)	IP67 Rated

10 Year Product Warranty • 25 Year Linear Power Warranty

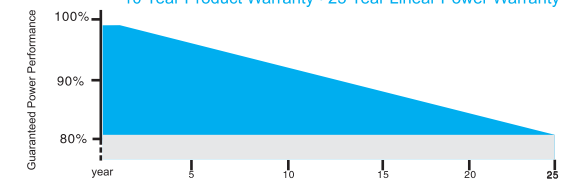

60 cells 245-265W
Mono Output Power

16.5% 0~+5W
Efficiency Tolerance

Quality CT solar panels provide more benefit guarantee to customers. CT solar is famous for its high power output , easy installation and durable .



CT-HS205-54P CT-HS210-54P
CT-HS215-54P CT-HS220-54P
CT-HS225-54P



High Efficiency:
High module conversion efficiency, through innovative manufacturing technology.



PID Free:
Limited power degradation of module caused by PID effect is guaranteed under 60 C/85% RH condition for mass production.



Low-light Performance:
Advanced glass and surface texturing allow for excellent performance in low-light environments.



Severe Weather Resilience:
Certified to withstand: wind load (2400 Pascal) and snow load (5400 Pascal).



Durability against extreme environmental conditions:
High salt mist and ammonia resistance certified by TUV NORD.



Temperature Coefficient:
Improved temperature coefficient decreases power loss during high temperatures.

Reliable Quality

- Fully automatic welding and automatic production line
- EL test to avoid defective panels .

54 cells 205-225W
Poly Output Power

15.5% 0~+5W
Efficiency Tolerance

Quality CT solar panels provide more benefit guarantee to customers. CT solar is famous for its high power output , easy installation and durable .

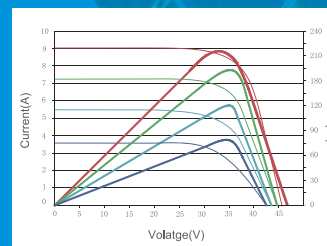

STC	CT-HS205-54P	CT-HS210-54P	CT-HS215-54P	CT-HS220-54P	CT-HS225-54P
最大额定功率(Pm)	205	210	215	220	225
最大工作电压(Vm)	26.1	26.2	26.3	26.4	26.5
最大工作电流(I _m)	7.86	8.02	8.18	8.33	8.49
开路电压(Voc)	33.2	33.3	33.4	33.5	33.6
短路电流(I _{sc})	8.26	8.42	8.58	8.74	8.91
组件转换效率(%)	14.1	14.4	14.8	15.1	15.5
组件工作温度(°C)	-40~+85°C				
最大系统电压(V)	1000V				
最大熔断电流(A)	15A				
功率公差(W)	0~+5W				

STC: 辐照度1000W/M2, 组件温度25°C, AM=1.5

NOCT	CT-HS205-54P	CT-HS210-54P	CT-HS215-54P	CT-HS220-54P	CT-HS225-54P
最大额定功率(Pm)	149	153	157	160	164
最大工作电压(Vm)	23.8	23.8	23.9	24.0	24.1
最大工作电流(I _m)	6.29	6.42	6.54	6.66	6.79
开路电压(Voc)	30.5	30.6	30.7	30.8	30.9
短路电流(I _{sc})	6.69	6.82	6.95	7.08	7.22

NOCT: 辐照度800W/M2, 环境温度20°C, AM=1.5, 风速1m/s

温度系数 (Temperature Coefficient)	
标称电池工作温度 (NOCT)	45 ± 2°C
温度系数 (Pmax)	-0.43%/°C
温度系数 (Voc)	-0.31%/°C
温度系数 (Isc)	0.046%/°C

机械系数 (Mechanical coefficient)	
电池类型 (Cells Type)	Polycrystalline Silicon
电池尺寸 (Cells Size)	156X156mm
电池数量 (Cells Number)	54 (6X9)
组件尺寸 (Module Size)	1480*982*30mm
重量 (Weight)	16kg
电缆线 (Cable)	4mm ² , 900mm
连接器 (Connector)	MC4 or MC Compatible
边框 (Frame)	Anodized Aluminum
接线盒 (Junction Box)	IP67 Rated

10 Year Product Warranty • 25 Year Linear Power Warranty

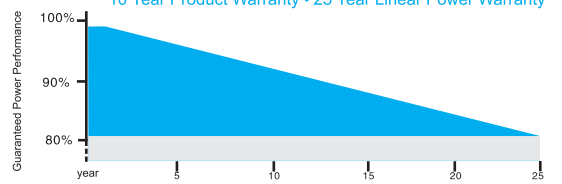



CT-HS215-54S CT-HS220-54S
CT-HS225-54S CT-HS230-54S
CT-HS235-54S



High Efficiency:
High module conversion efficiency, through innovative manufacturing technology.



PID Free:
Limited power degradation of module caused by PID effect is guaranteed under 60 °C/85% RH condition for mass production.



Low-light Performance:
Advanced glass and surface texturing allow for excellent performance in low-light environments.



Severe Weather Resilience:
Certified to withstand: wind load (2400 Pascal) and snow load (5400 Pascal).



Durability against extreme environmental conditions:
High salt mist and ammonia resistance certified by TÜV NORD.



Temperature Coefficient:
Improved temperature coefficient decreases power loss during high temperatures.

Reliable Quality

- Fully automatic welding and automatic production line
- EL test to avoid defective panels .

54 cells **205-235W**
Mono Output Power

16.2% **0~+5W**
Efficiency Tolerance

Quality CT solar panels provide more benefit guarantee to customers. CT solar is famous for its high power output , easy installation and durable .

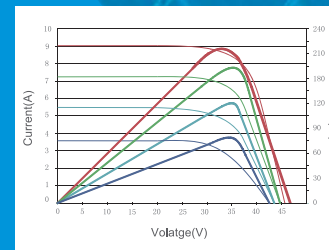

STC	CT-HS215-54S	CT-HS220-54S	CT-HS225-54S	CT-HS230-54S	CT-HS235-54S
最大额定功率(Pm)	215	220	225	230	235
最大工作电压(Vm)	27.3	27.4	27.5	27.6	27.7
最大工作电流(I _m)	7.89	8.04	8.19	8.34	8.49
开路电压(Voc)	33.6	33.7	33.8	33.9	34.0
短路电流(Isc)	8.41	8.56	8.71	8.87	9.03
组件转换效率(%)	14.8	15.1	15.5	15.8	16.2
组件工作温度(°C)	-40~+85°C				
最大系统电压(V)	1000V				
最大熔断电流(A)	15A				
功率公差(W)	0~+5W				

STC: 辐照度1000W/M2, 组件温度25°C, AM=1.5

NOCT	CT-HS215-54S	CT-HS220-54S	CT-HS225-54S	CT-HS230-54S	CT-HS235-54S
最大额定功率(Pm)	158	162	166	169	173
最大工作电压(Vm)	24.8	24.9	25.0	25.1	25.2
最大工作电流(I _m)	6.38	6.50	6.62	6.74	6.86
开路电压(Voc)	30.9	31.0	31.1	31.2	31.3
短路电流(Isc)	6.81	6.93	7.06	7.18	7.31

NOCT: 辐照度800W/M2, 环境温度20°C, AM=1.5, 风速1m/s

温度系数 (Temperature Coefficient)

标称电池工作温度 (NOCT)	45 ± 2°C
温度系数 (P _{max})	-0.43%/°C
温度系数 (Voc)	-0.31%/°C
温度系数 (Isc)	0.039%/°C

机械系数 (Mechanical coefficient)

电池类型 (Cells Type)	Monocrystalline Silicon
电池尺寸 (Cells Size)	156X156mm
电池数量 (Cells Number)	54 (6X9)
组件尺寸 (Module Size)	1480*982*30mm
重量 (Weight)	16kg
电缆线 (Cable)	4mm ² ,900mm
连接器 (Connector)	MC4 or MC Compatible
边框 (Frame)	Anodized Aluminum
接线盒 (Junction Box)	IP67 Rated

10 Year Product Warranty • 25 Year Linear Power Warranty

